

Clamex P-14

Pat. pend.

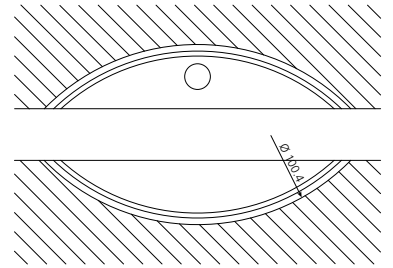
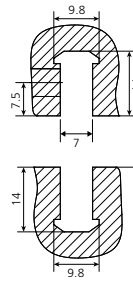
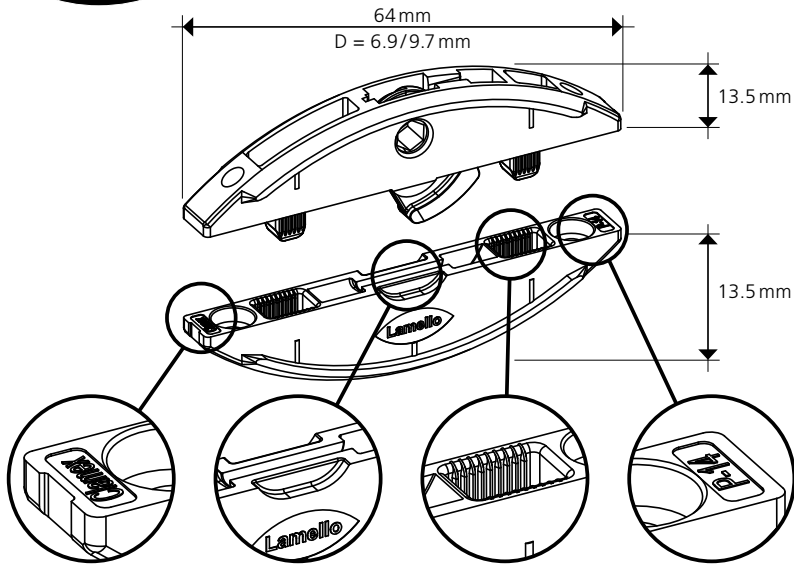
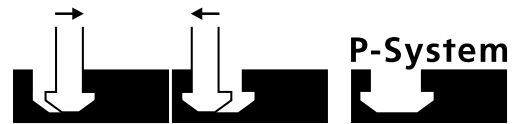

Zugbruchfestigkeit/ Tensile strength:

- Spanplatte/Particle board:
~ 800 N = 80 kg
- Buche massiv/Beech massive:
~ 1000 N = 100 kg
- MDF:
~ 900 N = 90 kg

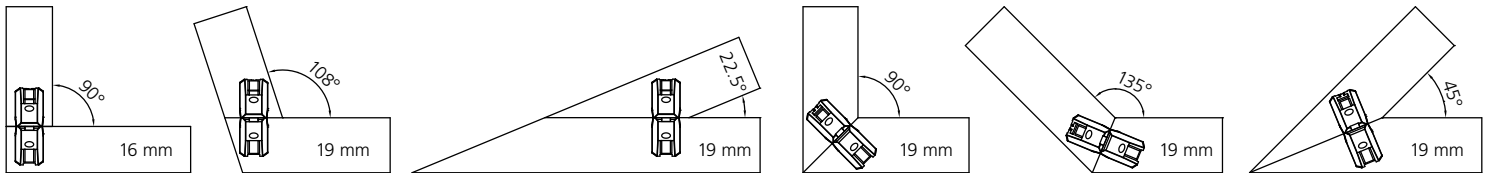
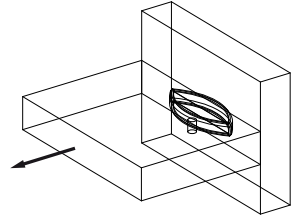

P-14

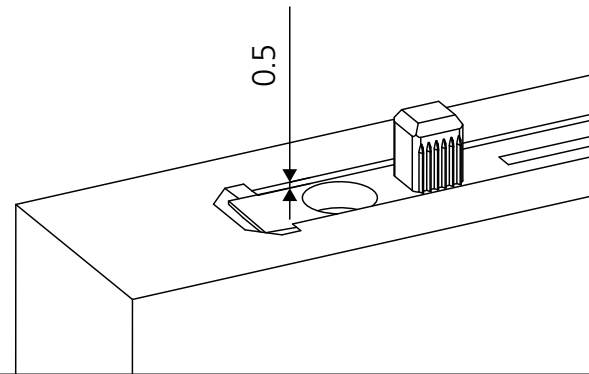
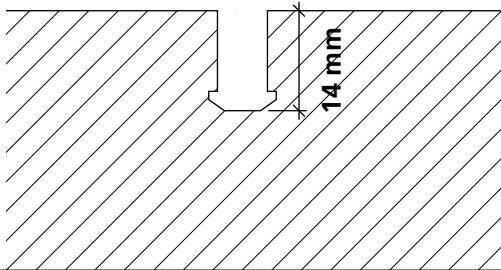

**Scharfe Fräser verwenden
Use sharp cutters**

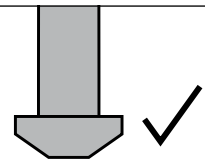
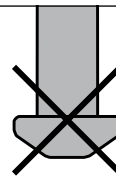

Divario P-18



Paar/Pair/ Paire/Paio	Art. No.
80	145550
300	145560
1000	145570

Tenso P-14 mit Vorspann-Funktion



Paar/Pair/ Paire/Paio	Art. No.
80	145415
300	145425
1000	145435

Clamex P Medium 14/10



Paar/Pair/ Paire/Paio	Art. No.
80	145370
300	145371

Clamex P-14



Paar/Pair/ Paire/Paio	Art. No.
80	145334
300	145346
1000	145356

Clamex P-10



Paar/Pair/ Paire/Paio	Art. No.
80	145372
300	145373
1000	145374

Bisco P-14 Bisco P-10



Stück/Piece/ Pièce/Pezzi	Art. No.
P-10 80	145304
300	145305
P-14 80	145301
300	145302
1000	145303

Zeta P2

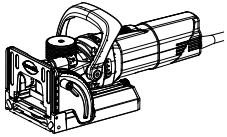

Art.No. 101402

P-14

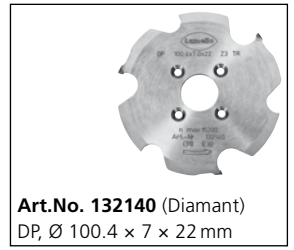
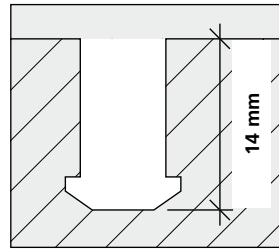
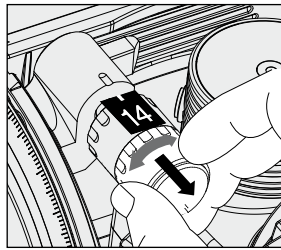

Art.No. 132140 (Diamant)
DP, Ø 100.4 x 7 x 22 mm

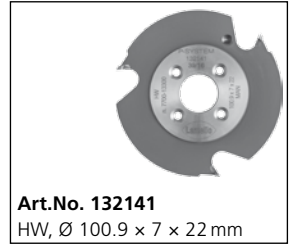
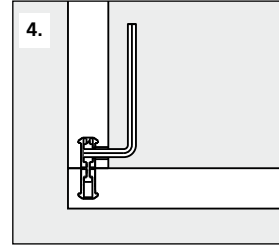
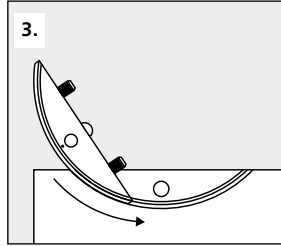
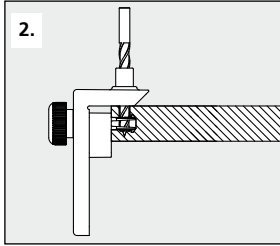
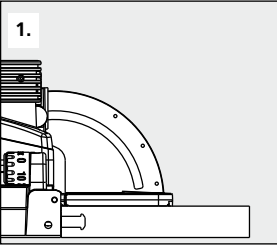

Art.No. 132141
HW, Ø 100.9 x 7 x 22 mm

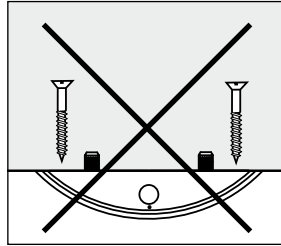

Art. No. 131506
Ø = 6 mm

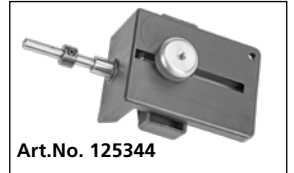

Art.No. 125344

CNC | Partner network: www.lamello.com

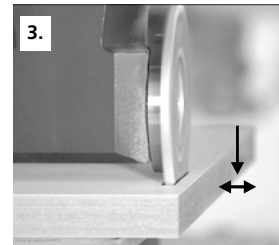
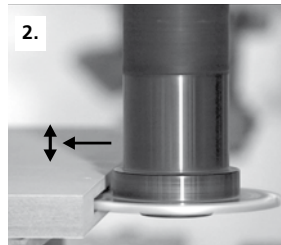
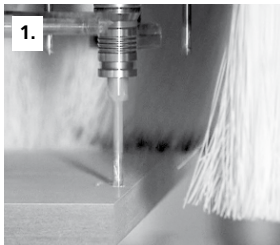
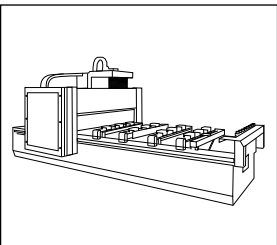

Art. No. 132142

DP, 100.4 x 7 x 30 mm
4 / 6.6 / DTK 48 mm

* Passend zu allen aufgeführten Fräsdornen
Suitable for all cutter arbors listed



Art. No. 132143

DP, 100.4 x 7 x 40 mm
4 / 5.5 / DTK 52 mm

Art. No. 132144

DP, 100.4 x 7 x 16 mm
4 / 5.5 / DTK 28 mm

* Art. No. 132150

20 x 50, L = 102 mm

* Art. No. 132151

25 x 60, L = 102 mm

* Art. No. 132152

16 x 50, L = 85 mm

* Art. No. 132153

16 x 55, L = 68 mm

* Art. No. 132154

16 x 50, L = 85 mm, mit Spannfläche (2°-schräg)/with clamping surface (2°-angle)

* Art. No. 132155

20 x 50, L = 85 mm, mit Spannfläche (2°-schräg)/with clamping surface (2°-angle)



Abdeckkappen / Cover caps

100 Stück / 100 Pieces

90°

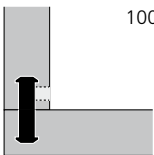

45°

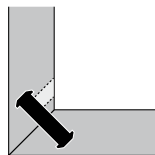

RAL	Art. No.
9010	335280
9011	335281
1014	335282
1011	335283
8007	335284
8017	335289
9002	335285
7035	335286
7040	335287
7031	335288

RAL	Art. No.
9010	335380
9011	335381
1014	335382
1011	335383
8017	335384
7022	335388



Art. No. 131556
Ø = 6 / 10 mm
l = 100 / 35 mm

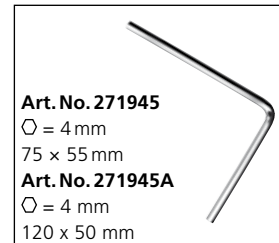

Art. No. 271945
Ø = 4 mm
75 x 55 mm
Art. No. 271945A
Ø = 4 mm
120 x 50 mm



Art. No. 251993
Ø = 4 mm
flexibel

